

CLIMATE COMFORT | TEMPERATURE-CONTROLLED TRANSPORT

THE MOBILE COMPRESSOR REFRIGERATED CONTAINERS



MOBILE REFRIGERATED CONTAINERS



A WORLD OF COMFORT







THE MOBILE COMPRESSOR REFRIGERATED CONTAINERS

Our compressor refrigerated containers are the flexible, convenient solution for professional users who have to transport perishable goods at constant temperatures in conventional vehicles or delivery vans, while complying with standards.

The advantages of the mobile compressor refrigerated containers from Eberspächer are clear: Purchasing and maintenance costs are significantly lower compared to complete cooling modifications. Furthermore, no additional cooling units or special vehicle equipment is required. Depending on the model, the compressor refrigerated containers are simply secured in the vehicle and provided with electrical power. They represent an independent “complete system” within the vehicle. The large containers additionally feature metal feet, allowing them to be transported with a pallet jack or forklift. This makes them particularly suitable for fleet vehicles and leased vehicles.

Most of the compressor refrigerated containers are also available with an integrated heating function in order to maintain a constant transport temperature, regardless of the ambient temperature. This permits temperature control from -30 °C to $+40\text{ °C}$, additionally allowing mixed tours without difficulty. All refrigerated containers are made from robust rotomolded polyethylene and are particularly easy to clean. Certified refrigerated containers satisfying the strict GDP guidelines for pharmaceutical transport are also available.

THE COMPRESSOR REFRIGERATED CONTAINERS ARE VERSATILE:

Logistics industry:

- Pharmaceutical logistics industry (wholesale trade)
- Medical industry (blood transport, blood samples, insulin, vaccines, organs)
- Pharmacies
- Laboratory requirements (water samples, DNA, etc.)

Food industry:

- Ice cream vendors/transport/parlors
- Seafood dealers
- Hunters and fishermen
- Restaurant industry (catering, seafood, sushi, etc.)
- Vending machine operators (food/snacks)
- Bakers/confectioners



Operation with mains connection possible. All required connecting cables (12 V/24 V/230 V) are included with delivery for all devices.

CERTIFIED QUALITY AND SAFETY

QUALITY AND SAFETY:

All devices comply with the following standards:

- Low Voltage Directive 2006/95/EC, based on EC harmonized standards: EN60335-1:2002 +A11 +A1 +A12+corr. +A2:2006 +A13:2008, EN60335-2-34:2002 +A1:2005 +A11:2004
- EMC Directive 2004/108/EC, based on EC harmonized standards: EN55014-1 (2006), EN55014-2 (1997) +A1 (2002), EN61000-3-2 (2006), EN61000-3-3 (1995) +A1 (2001) +A2 (2005)
- ECE Regulation 10.03
- European Directive 2002/95/EC (RoHS)
- European Directive 2002/96/EC (WEEE)
- Commission Directive 2002/72/EC (relating to plastic materials and articles intended to come into contact with foodstuffs)
- Regulation (EC) 852/2004 on the hygiene of foodstuffs (HACCP)

GDP CERTIFICATION:

According to EU Directive 2013/C 343/01, Good Distribution Practice (GDP), it must be ensured that equipment used to transport and store drugs is suitable for the respective application and is equipped so that the products are not exposed to conditions that could impair their quality or their packaging.









In collaboration with European Institute for Pharma Logistics GmbH (EIPL), Eberspächer qualified a model F0915/NDH refrigerated/heated container according to GDP criteria. This process involved performing the qualification steps of design qualification (DQ), installation qualification (IQ) and operation qualification (OQ). As part of operation qualification (OQ), the refrigerated/heated container was tested at an outside temperature of $\geq +30\text{ °C}$ with an interior temperature of $+2\text{ °C}$ to $+8\text{ °C}$. Additional tests were performed at an outside temperature of $\leq -10\text{ °C}$ with interior temperatures from $+2\text{ °C}$ to $+8\text{ °C}$ and $+15\text{ °C}$ to $+25\text{ °C}$. Additionally, door-opening and cooler/heater failure simulations were performed.



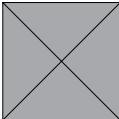

THE RIGHT REFRIGERATED CONTAINER FOR EVERY APPLICATION

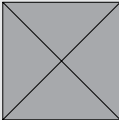
PRODUCT RANGE FROM 22 TO 915 L CAPACITY WITH TEMPERATURE CONTROL FROM -35°C TO $+40^{\circ}\text{C}$



NDN		Cooling function to 0°C for fresh-product transport (-10°C with 140 l)
NDH	 	Heating and cooling function for temperature-controlled transport with temperature control between 0°C and $+30^{\circ}\text{C}$ (between -10°C and $+30^{\circ}\text{C}$ with 140 l)
FDN	 	Cooling/deep-freezing function to -21°C / -24°C for refrigerated/frozen transport
FDH	 	Heating and cooling (deep-freezing) function for temperature-controlled transport with temperature control between -24°C and $+40^{\circ}\text{C}$ (-21°C and $+30^{\circ}\text{C}$ with containers from 140 l)
XFDN		Deep-freezing function to -30°C for special transport
XFDH	 	Heating and cooling (deep-freezing) function for temperature-controlled transport with temperature control between $+40^{\circ}\text{C}$ and -35°C for special transport



22 LITERS MOBILE REFRIGERATED CONTAINERS



22 LITERS – TOP LOADER (LOADED FROM ABOVE)

Technical designation	T0022 FDN	T0022 FDH
Temperature range:	-24 °C 	+40 °C to -24 °C 
Product code	81 0000 00 0145	81 0000 00 0196
Max. current draw, direct current	9 A at 12 V/4 A at 24 V	9 A at 12 V/4 A at 24 V
Max. current draw, alternating current	1.6 A at 100 V/0.8 A at 240 V 50–60 Hz	1.6 A at 100 V/0.8 A at 240 V 50–60 Hz
Wall foam insulation	65–70 mm PU*	65–70 mm PU*
Weight	17 kg	17 kg
External dimensions (WxHxD)	38 x 59 x 48 cm	38 x 59 x 48 cm

* PU = wall foam insulation with polyurethane rigid foam ($K < 0.4 \text{ W}/(\text{m}^2\text{K})$)

DIMENSIONS

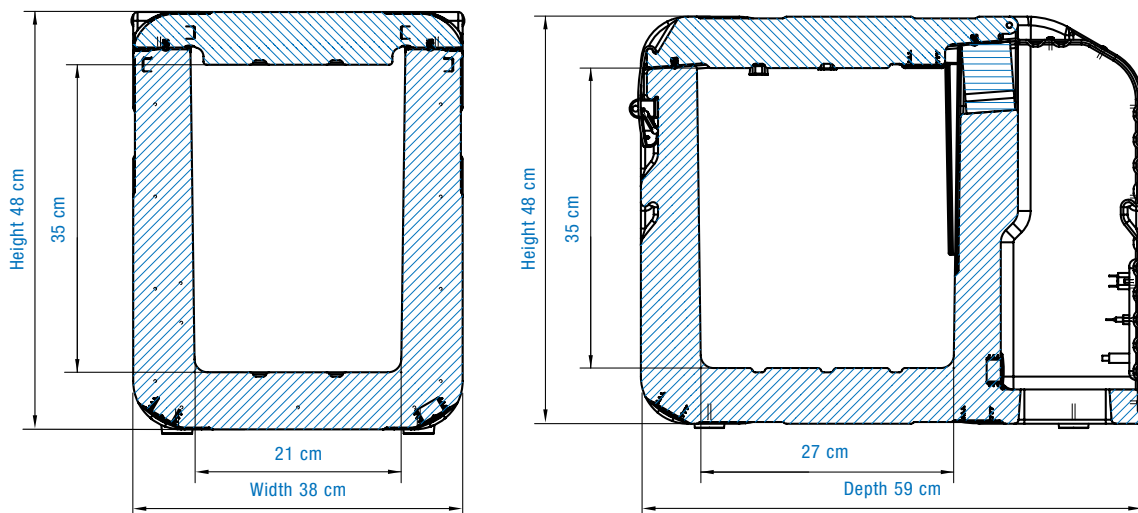





32 LITERS MOBILE REFRIGERATED CONTAINERS



32 LITERS – TOP LOADER (LOADED FROM ABOVE)

Technical designation	T0032 FDN	T0032 FDH
Temperature range:	-24 °C 	+40 °C to -24 °C 
Product code	81 0000 00 0146	81 0000 00 0197
Max. current draw, direct current	9 A at 12 V/4 A at 24 V	9 A at 12 V/4 A at 24 V
Max. current draw, alternating current	1.6 A at 100 V/0.8 A at 240 V 50–60 Hz	1.6 A at 100 V/0.8 A at 240 V 50–60 Hz
Wall foam insulation	65–70 mm PU*	65–70 mm PU*
Weight	19 kg	19 kg
External dimensions (WxHxD)	39 x 67 x 48 cm	39 x 67 x 48 cm

* PU = wall foam insulation with polyurethane rigid foam ($K < 0.4 \text{ W}/(\text{m}^2\text{K})$)

DIMENSIONS

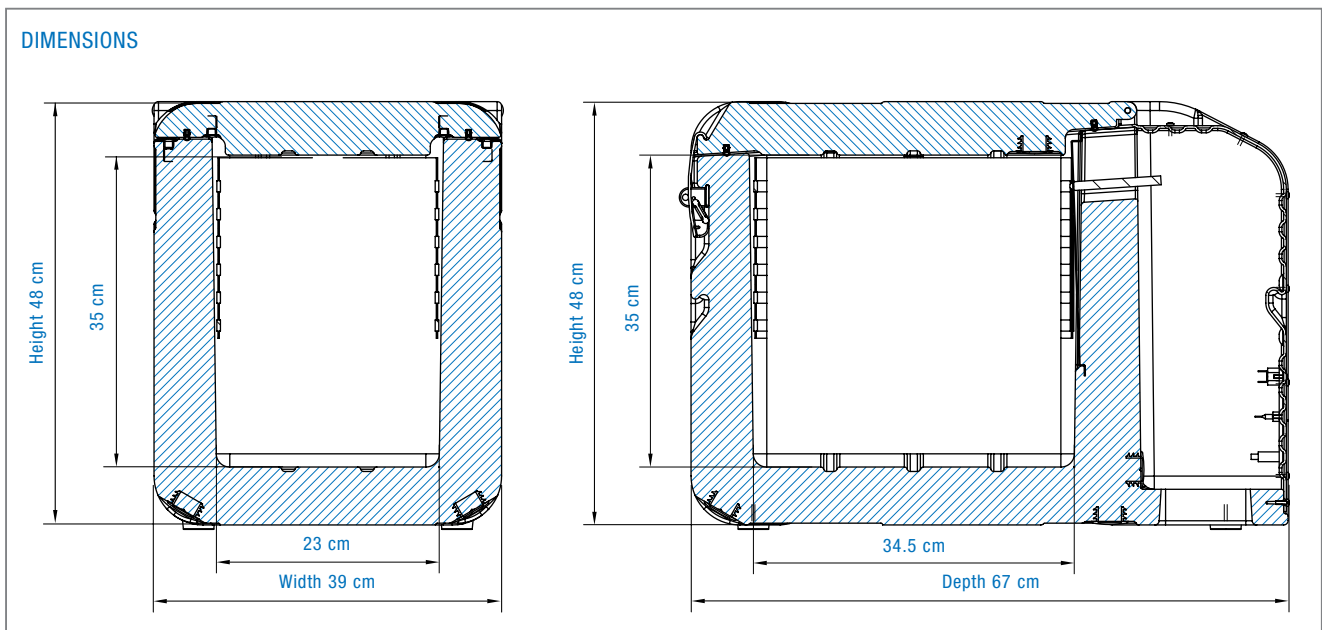









56 LITERS MOBILE REFRIGERATED CONTAINERS



56 LITERS – TOP LOADER (LOADED FROM ABOVE)

Technical designation	T0056 FDN	T0056 FDH	T0056 XFDH
Temperature range:	-24 °C  	+40 °C to -24 °C  	+40 °C to -35 °C  
Product code	81 0000 00 0147	81 0000 00 0198	81 0000 00 0399
Max. current draw, direct current	9 A at 12 V/4 A at 24 V	9 A at 12 V/4 A at 24 V	25 A at 12 V
Max. current draw, alternating current	1.6 A at 100 V/0.8 A at 240 V 50 – 60 Hz	1.6 A at 100 V/0.8 A at 240 V 50 – 60 Hz	1.3 A at 230 V
Wall foam insulation	70 mm PU*	70 mm PU*	70 mm PU*
Weight	26 kg	26 kg	29 kg
External dimensions (WxHxD)	50 x 80 x 50 cm	50 x 80 x 50 cm	50 x 80 x 50 cm

* PU = wall foam insulation with polyurethane rigid foam ($K < 0.4 \text{ W/(m}^2\text{K)}$)
Accessories depend on the model.

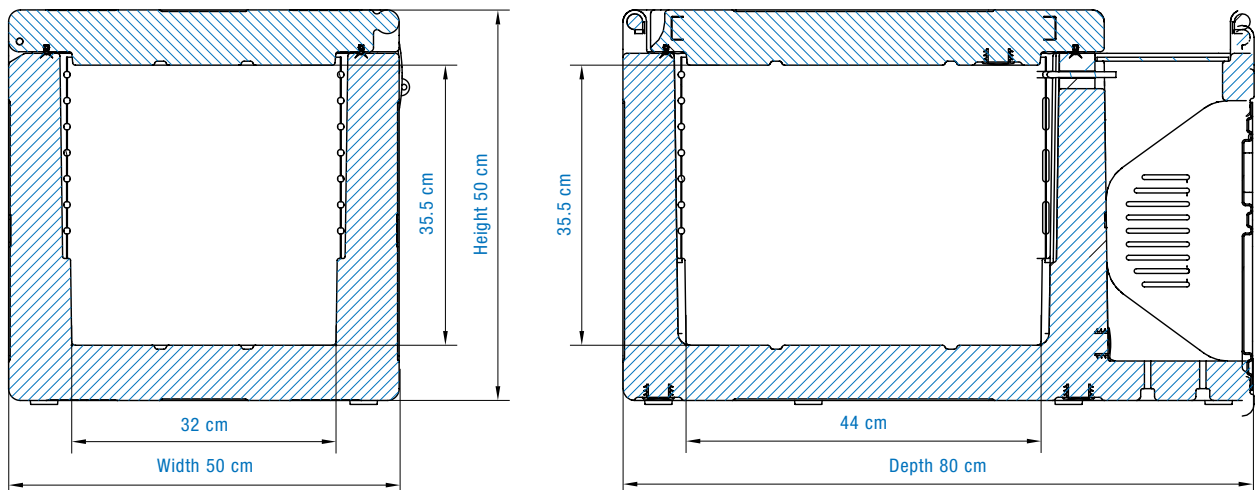

DIMENSIONS



82 LITERS MOBILE REFRIGERATED CONTAINERS



82 LITERS – TOP LOADER (LOADED FROM ABOVE)

Technical designation	T0082 FDN	T0082 FDH	T0082 XFDH
Temperature range:	-24 °C 	+40 °C to -24 °C 	+40 °C to -35 °C 
Product code	81 0000 00 0148	81 0000 00 0199	81 0000 00 0400
Max. current draw, direct current	9 A at 12 V/4 A at 24 V	9 A at 12 V/4 A at 24 V	25 A at 12 V
Max. current draw, alternating current	1.6 A at 100 V/0.8 A at 240 V 50–60 Hz	1.6 A at 100 V/0.8 A at 240 V 50–60 Hz	1.3 A at 230 V
Wall foam insulation	80 mm PU*	80 mm PU*	80 mm PU*
Weight	29 kg	29 kg	32 kg
External dimensions (WxHxD)	56 x 94 x 56 cm	56 x 94 x 56 cm	56 x 94 x 56 cm

* PU = wall foam insulation with polyurethane rigid foam ($K < 0.4 \text{ W}/(\text{m}^2\text{K})$)
Accessories depend on the model.

DIMENSIONS

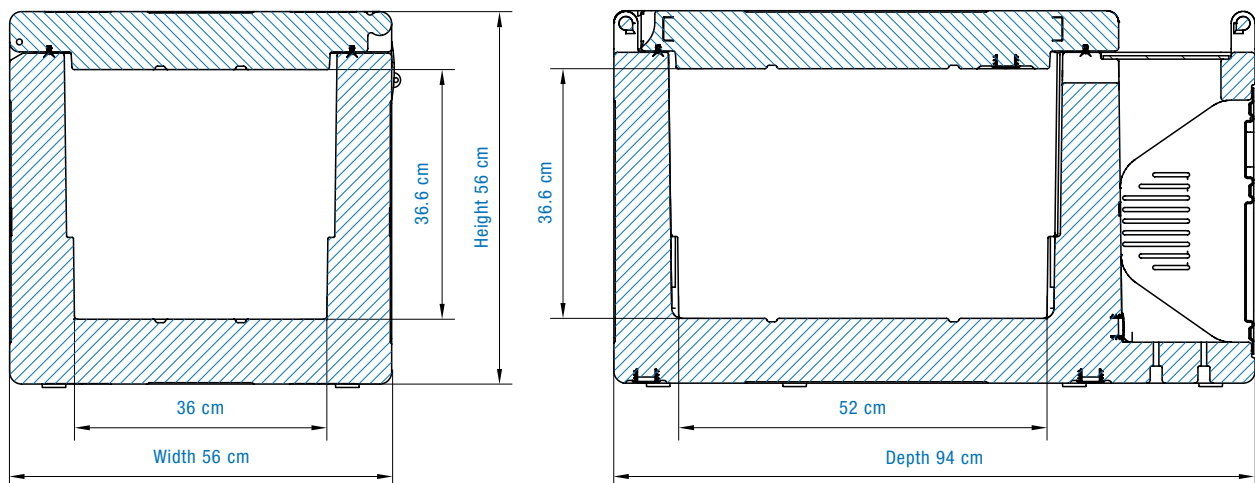



140 LITERS MOBILE REFRIGERATED CONTAINERS



140 LITERS – FRONT LOADER (LOADED FROM FRONT)

Technical designation	F0140 NDN	F0140 FDN	F0140 NDH	F0140 FDH	F0140 XFDN
Temperature range:	-10 °C 	-21 °C 	+30 °C to -10 °C 	+30 °C to -21 °C 	-30 °C
Product code	81 0000 00 0153	81 0000 00 0154	81 0000 00 0200	81 0000 00 0402	81 0000 00 0401
Max. current draw, direct current	9 A at 12 V/4 A at 24 V	18 A at 12 V/8 A at 24 V	9 A at 12 V/4 A at 24 V	18 A at 12 V	25 A at 12 V
Max. current draw, alternating current	1.6 A at 100 V / 0.8 A at 240 V 50–60 Hz	3 A at 100 V / 1.5 A at 240 V 50–60 Hz	1.6 A at 100 V / 0.8 A at 240 V 50–60 Hz	0.9 A at 230 V	1.3 A at 230 V
Wall foam insulation	80–100 mm PU*	80–100 mm PU*	80–100 mm PU*	80–100 mm PU*	80–100 mm PU*
Weight	40 kg	40 kg	42 kg	43 kg	42 kg
External dimensions (WxHxD)	100 x 100 x 62 cm	100 x 100 x 62 cm	100 x 100 x 62 cm	100 x 100 x 62 cm	100 x 100 x 62 cm

* PU = wall foam insulation with polyurethane rigid foam ($K < 0.4 \text{ W}/(\text{m}^2\text{K})$)

Accessories depend on the model.

DIMENSIONS

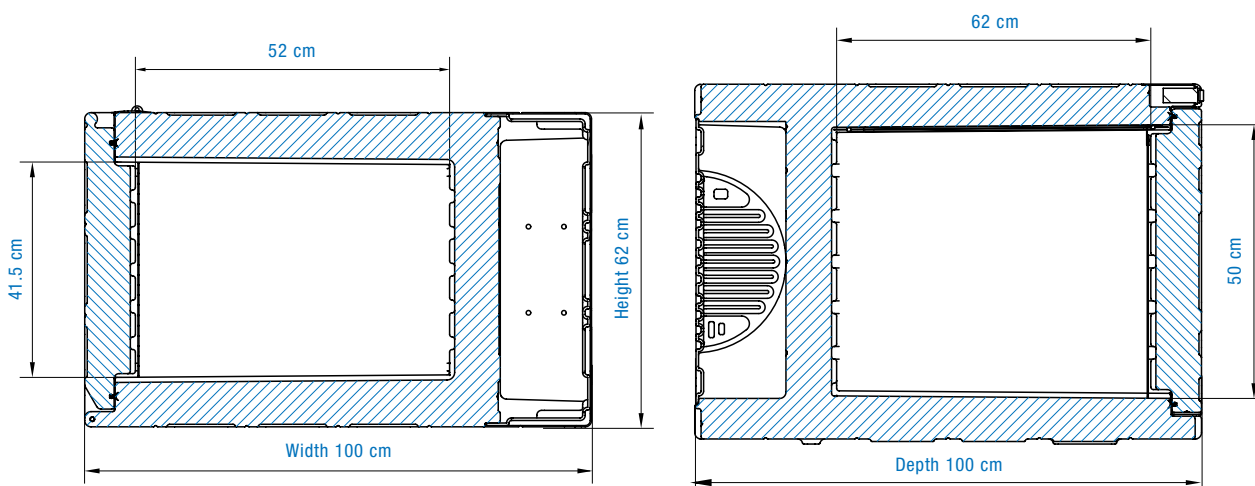





330 LITERS

MOBILE REFRIGERATED CONTAINERS



330 LITERS – FRONT LOADER (LOADED FROM FRONT)

Technical designation	F0330 NDN	F0330 FDN	F0330 NDH	F0330 FDH	F0330 XFDN
Temperature range:	0 °C 	-21 °C 	+30 °C to 0 °C 	+30 °C to -21 °C 	-30 °C 
Product code	81 0000 00 0155	81 0000 00 0156	81 0000 00 0202	81 0000 00 0442	81 0000 00 0403
Max. current draw, direct current	9 A at 12 V/4 A at 24 V	18 A at 12 V/8 A at 24 V	9 A at 12 V/4 A at 24 V	18 A at 12 V	25 A at 12 V
Max. current draw, alternating current	1.6 A at 100 V / 0.8 A at 240 V 50–60 Hz	3 A at 100 V / 1.5 A at 240 V 50–60 Hz	1.6 A at 100 V / 0.8 A at 240 V 50–60 Hz	0.9 A at 230 V	1.3 A at 230 V
Wall foam insulation	100 mm PU*	100 mm PU*	100 mm PU*	100 mm PU*	105 mm PU*
Weight	100 kg	100 kg	105 kg	105 kg	90 kg
External dimensions (WxHxD)	102 x 102 x 91 cm	102 x 102 x 91 cm	102 x 102 x 91 cm	102 x 102 x 91 cm	102 x 102 x 91 cm

* PU = wall foam insulation with polyurethane rigid foam ($K < 0.4 \text{ W}/(\text{m}^2\text{K})$)

Accessories depend on the model. Delivered with a rack – max. load 35 kg.

DIMENSIONS

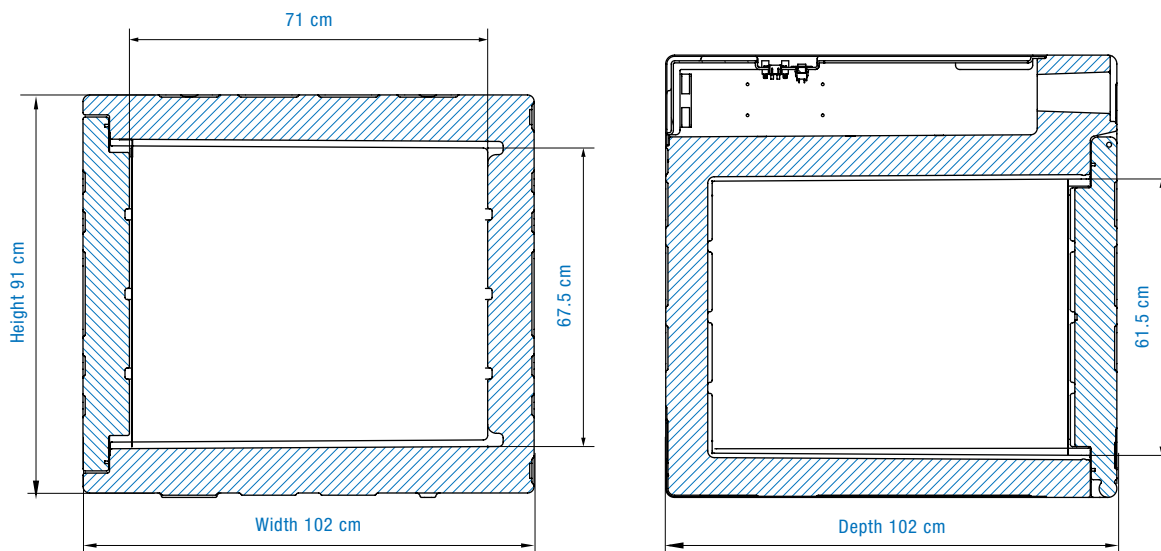



Refrigerated container with metal feet:
transportable by pallet jack or forklift

720 LITERS MOBILE REFRIGERATED CONTAINERS



720 LITERS – FRONT LOADER (LOADED FROM FRONT)

Technical designation	F0720 NDN	F0720 FDN	F0720 NDH	F0720 FDH
Temperature range:	0 °C 	-21 °C 	+30 °C to 0 °C 	+30 °C to -21 °C
Product code	81 0000 00 0421	81 0000 00 0422	81 0000 00 0443	81 0000 00 0444
Max. current draw, direct current	18 A at 12 V	25 A at 12 V	18 A at 12 V	25 A at 12 V
Max. current draw, alternating current	0.9 A at 230 V	1.3 A at 230 V	0.9 A at 230 V	1.3 A at 230 V
Wall foam insulation	125 mm PU*	125 mm PU*	125 mm PU*	125 mm PU*
Weight	140 kg	145 kg	145 kg	150 kg
External dimensions (WxHxD)	110 x 140 x 110 cm	110 x 140 x 110 cm	110 x 140 x 110 cm	110 x 140 x 110 cm

* PU = wall foam insulation with polyurethane rigid foam ($K < 0.4 \text{ W}/(\text{m}^2\text{K})$)
Accessories depend on the model.

DIMENSIONS

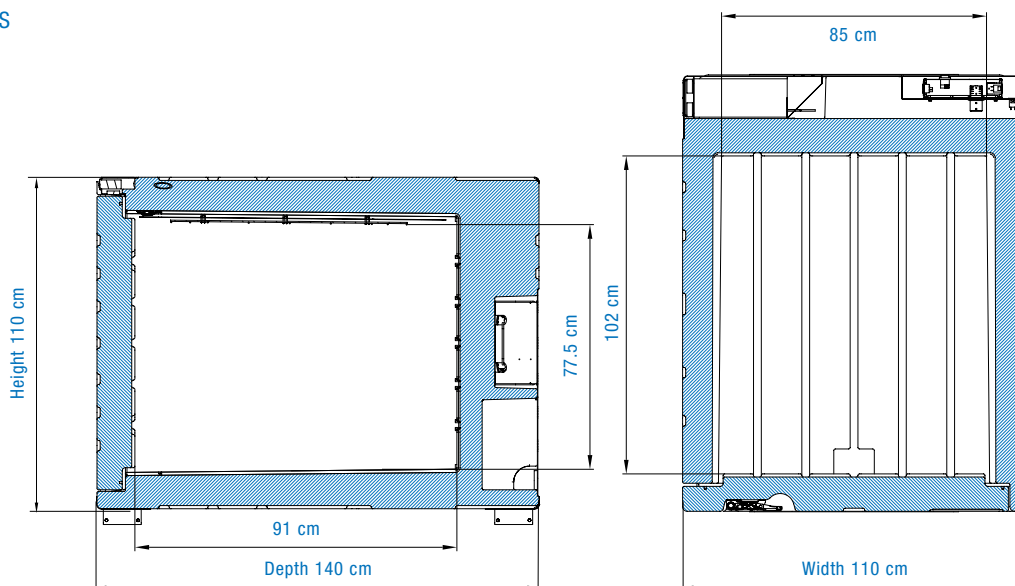







Refrigerated container with metal feet:
transportable by pallet jack or forklift

915 LITERS

MOBILE REFRIGERATED CONTAINERS



915 LITERS – FRONT LOADER (LOADED FROM FRONT)

Technical designation	F0915 NDN	F0915 FDN**	F0915 NDH	F0915 FDH
Temperature range:	0 °C 	-21 °C 	+30 °C to 0 °C  	+30 °C to -21 °C  
Product code	81 0000 00 0206	81 0000 00 0298	81 0000 00 0445	81 0000 00 0446
Max. current draw, direct current	18 A at 12 V/8 A at 24 V	25 A at 12 V	18 A at 12 V	25 A at 12 V
Max. current draw, alternating current	3 A at 100 V/1.5 A at 240 V 50–60 Hz	3 A at 100 V/1.5 A at 240 V 50–60 Hz	0.9 A at 230 V	1.3 A at 230 V
Wall foam insulation	130 mm PU*	130 mm PU*	130 mm PU*	130 mm PU*
Weight	160 kg	160 kg	165 kg	165 kg
External dimensions (WxHxD)	120 x 151 x 118 cm	120 x 151 x 118 cm	120 x 151 x 118 cm	120 x 151 x 118 cm

* PU = wall foam insulation with polyurethane rigid foam ($K < 0.28 \text{ W}/(\text{m}^2\text{K})$)

** F0915 FDN cannot be operated with 24 V. It can be operated only with an additional, external converter that is not included in the scope of delivery.

Accessories depend on the model.

DIMENSIONS

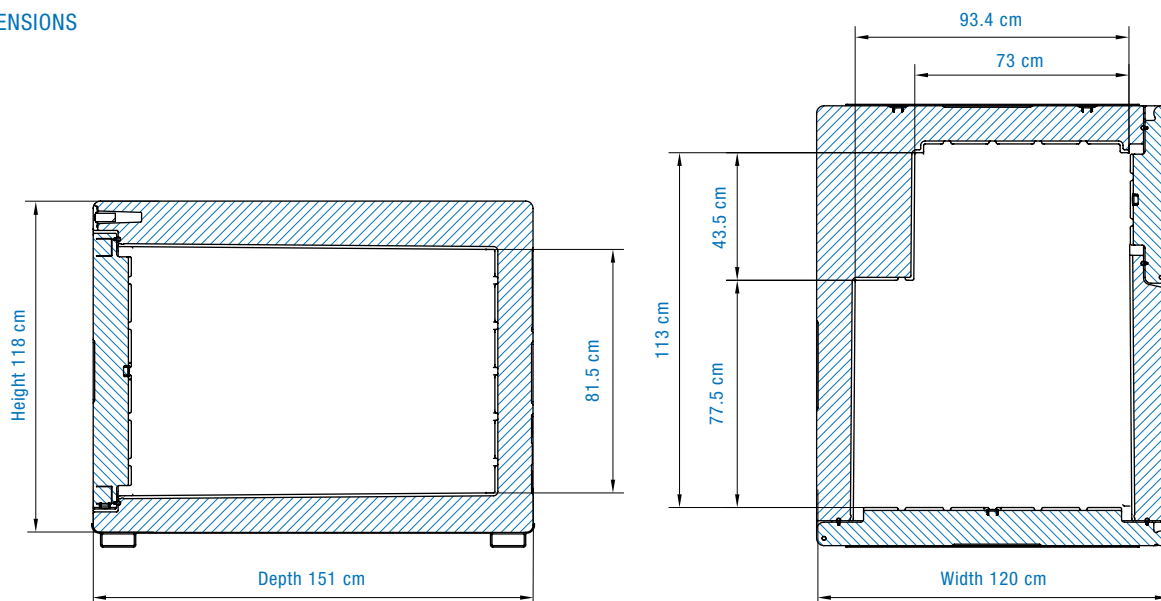

ACCESSORIES

MOBILE REFRIGERATED CONTAINERS

RACKS:

- Available for F0140, F0330 and F0720
- Load up to 35 kg

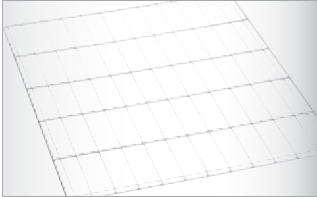

RACK KIT:

- Available for F0915



STRIP CURTAIN:

This serves to maintain the temperature in the container when the door is open.

- Available for F0140 (all models) and F0330 NDN
- Available for all models with side doors
- Included in the scope of delivery for F0330 FDN and F0720 (all models)
- Included in the scope of delivery for the main door for F0915 NDN and F0915 FDN



METAL FEET FOR PALLET TRANSPORT:

- Available for F0330
- Included in the scope of delivery for F0720 and F0915



METAL TROLLEY WITH ROLLERS:

- Available for F0140 and F0330



CARGO SECURING SET:

- Available for F0140 and F0330



DISPLAY IN DRIVER'S CAB:

- Available for F0330, F0720 and F0915
- Second display

COMBO UNIT CONNECTOR:

To fasten two containers together.

- Available for F0330

Product code	Accessories
24 9988 00 0078	Outer socket outlet EBS 230 V
24 9988 00 0080	E connection for 2nd battery
24 9988 00 0079	Undervoltage protection
81 0000 00 0187	Shelf/partition wall F0140/NDN, T0140
81 0000 00 0238	Shelf/partition wall F0140/NDH
81 0000 00 0191	Shelf/partition wall F0330/NDN, T0330
81 0000 00 0204	Shelf/partition wall F0330/NDH, F0330/FDN
81 0000 00 0239	Galvanized trolley F0140
81 0000 00 0240	Galvanized trolley T0140
81 0000 00 0241	Galvanized trolley F0330
81 0000 00 0242	Galvanized trolley T0330
81 0000 00 0243	Galvanized pallet floor tray F0330
81 0000 00 0244	Galvanized pallet floor tray T0330
81 0000 00 0210	Remote display kit F0330/F0915
81 0000 00 0245	Stainless-steel stand for GN containers (2) F0140/NDN
81 0000 00 0246	Stainless-steel stand for containers 60 x 40 (2) F0140/NDN
81 0000 00 0247	Stainless-steel stand for GN containers (2) F0330/NDN
81 0000 00 0248	Stainless-steel stand for cases 60 x 40 (2) F0330/NDN
81 0000 00 0249	Stainless-steel stand for shelves (4) F0750
81 0000 00 0250	Stainless-steel stand for shelves (4) F0785/F0915
81 0000 00 0251	Cable compartment F0750/F0915
81 0000 00 0252	Cable compartment F0785
81 0000 00 0253	Fastening kit F0330
81 0000 00 0254	Fastening kit F0750/F0785/F0915
81 0000 00 0255	Stainless-steel support for shelves F0750/F0785/F0915
81 0000 00 0256	Fastening kit T0022
81 0000 00 0257	Fastening kit T0032

VEHICLE COMPATIBILITY

MOBILE REFRIGERATED CONTAINERS

MODEL	F0330	F0720	F0915 (including pallet)
Citroën Nemo	✓	—	—
Citroën Berlingo L1	✓	✓	—
Citroën Berlingo L2	✓	✓	—
Citroën Jumpy	✓	✓	✓*
Fiat Fiorino	✓	—	—
Fiat Doblò (old model)	✓	✓	—
Fiat Doblò (new model)	✓	✓	✓
Fiat Scudo	✓	✓	✓
Ford Transit Connect (short wheelbase)	✓	✓	—
Ford Transit Connect (long wheelbase)	✓	✓	✓*
Mercedes Citan Compact	✓	—	—
Mercedes Citan Long	✓	✓	—
Mercedes Citan Extra Long	✓	✓	—
Mercedes Vito	✓	✓	✓
Nissan NV 2000	✓	✓	—
Opel Combo (old model)	✓	—	—
Opel Combo (from model year 2012)	✓	✓	✓
Opel Vivaro	✓	✓	✓
Peugeot Bipper	✓	—	—
Peugeot Partner L1	✓	✓	—
Peugeot Partner L2	✓	✓	—
Peugeot Expert	✓	✓	✓
Renault Kangoo Compact	✓	—	—
Renault Kangoo Express	✓	✓	—
Renault Kangoo Maxi	✓	✓	—
Toyota HiAce	✓	✓	✓
Volkswagen Caddy	✓	—	—

* Only without pallet



Netherlands

Eberca B.V.

Marconistraat 2
3281 NB Numansdorp
Phone: +31 (0)186 621955
info@eberca.nl
www.eberca.nl

Belgium

Eberca BVBA

Esperantolaan 2
3001 Haasrode
Phone: +32 (0)16 402500
sales@eberca.be
www.eberca.nl



Eberspächer Climate Control Systems GmbH & Co. KG
Eberspächerstrasse 24
73730 Esslingen
GERMANY
Phone: +49 711 939 00
Fax: +49 711 939 0634
info@eberspaecher.com
www.eberspaecher.com

